

AUTEL® MAXISYS™

ADAS

ADVANCED DRIVER ASSISTANCE SYSTEM

AUTEL ADAS
MAG600 CALIBRATION FRAME

AUTEL ADAS
STANDARD CALIBRATION FRAME

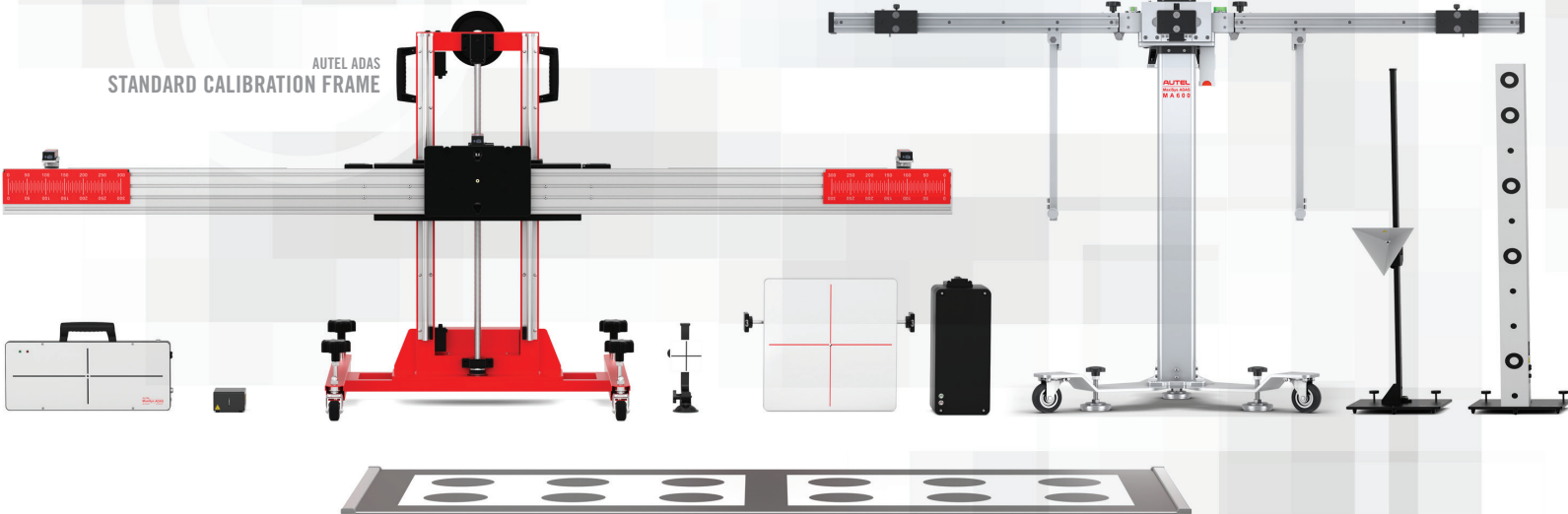

EXPANSION PACKAGES

EXPAND THE CAPABILITIES OF YOUR EXISTING AUTEL ADAS FRAMES

CALIBRATION FOR CAMERA, RADAR & NIGHT VISION-BASED SYSTEMS.
FOR COLLISION, GLASS REPLACEMENT & SPECIALTY REPAIR SHOPS.



WWW.MAXISYSADAS.COM



ADAS STANDARD FRAME LDW PACKAGE



LDW TARGET 1 PART NO: LDWTARGET1

EXPANDS LANE DEPARTURE WARNING CALIBRATION CAPABILITIES

Warns driver when vehicle begins to move out of freeway lane.
 Designed to minimize caused collisions: driver error, distractions and drowsiness. **COMPATIBLE WITH THE AUTEL STANDARD FRAME >**
*Frame not included with package.

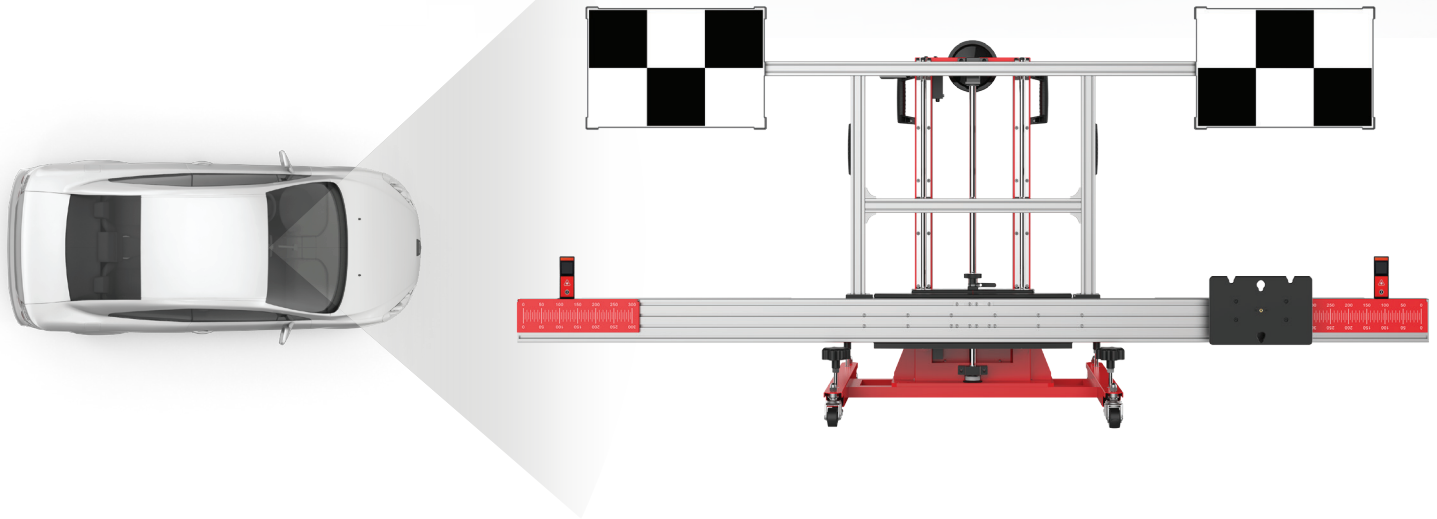

LANE DEPARTURE WARNING

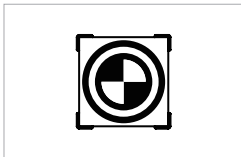

HONDA/ACURA LDWI
CSC0601-05

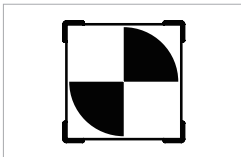

NISSAN/INFINITI LDWI
CSC0601-06-L

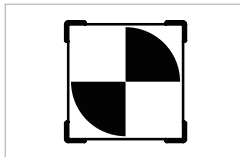

NISSAN/INFINITI LDWI
CSC0601-06-R

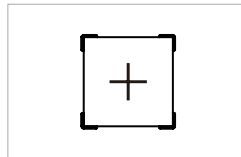

HYUNDAI/KIA LDWI
CSC0601-09

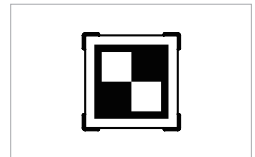

TOYOTA/LEXUS LDWI
CSC0601-11

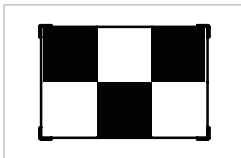

NISSAN LDWII
CSC0601-03-L

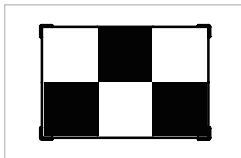

NISSAN LDWII
CSC0601-03-R

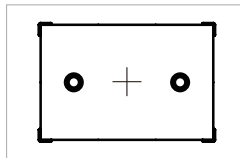

MERCEDES LDWII
CSC0601-02

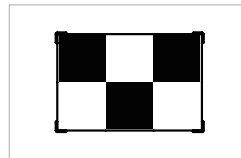

HONDA/ACURA LDWII
CSC0601-08-L

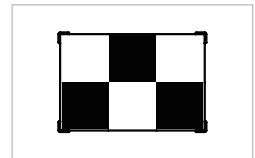

HONDA/ACURA LDWII
CSC0601-08-R

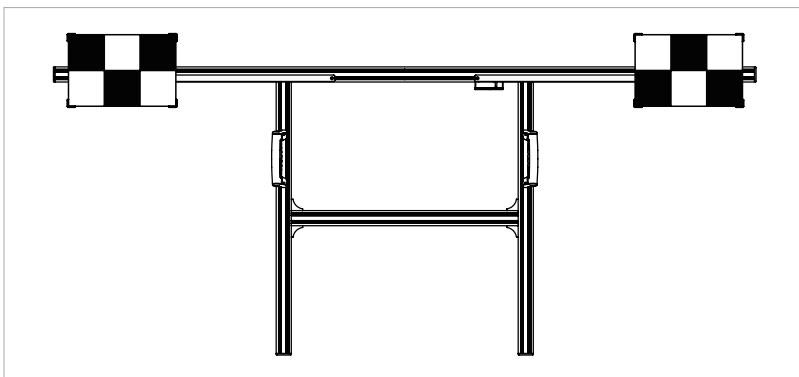

TARGET BOARD HOLDER LDWII
0600-22

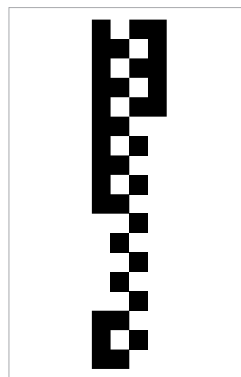

HYUNDAI/KIA LDWII
CSC0601-07

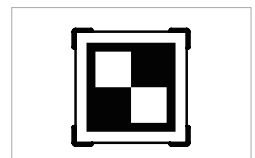

TOYOTA/LEXUS LDWII
CSC0601-15

REQUIRED PARTS FOR THIS PACKAGE • Autel ADAS Standard Calibration Frame • MaxiSYS tablet with ADAS Calibration Software

ADAS STANDARD FRAME LDW PACKAGE



LDW TARGET 2

PART NO:
LDWTARGET2

EXPANDS LANE DEPARTURE WARNING CALIBRATION CAPABILITIES

Warns driver when vehicle begins to move out of freeway lane. Designed to minimize caused collisions: driver error, distractions and drowsiness. **COMPATIBLE WITH THE AUTEL STANDARD FRAME >**
*Frame not included with package.

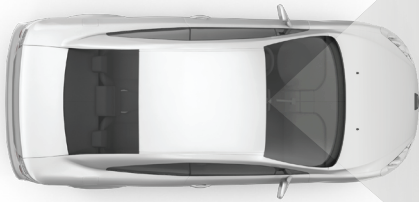

LANE DEPARTURE WARNING

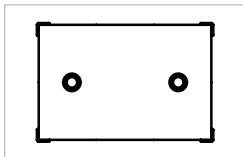

MAZDA LDWI
CSC0601-12

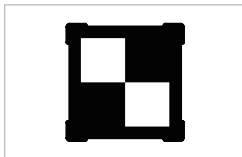

MITSUBISHI LDWI
CSC0601-22-L

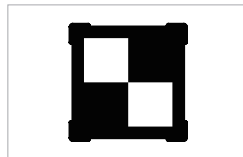

MITSUBISHI LDWI
CSC0601-22-R

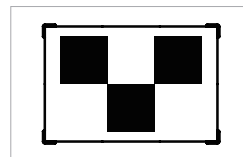

MAZDA LDWII
CSC0601-13-L

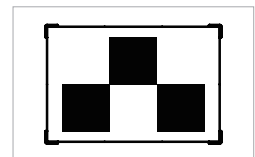

MAZDA LDWII
CSC0601-13-R



SUBARU LDWI
CSC0601-14

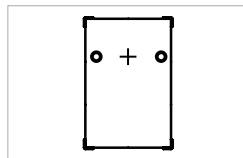

MERCEDES LDWII
CSC0601-19

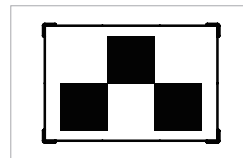

NISSAN/INFINITI LDWIII
CSC0601-04-R

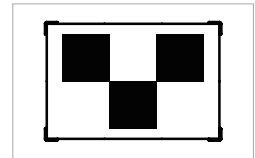

NISSAN/INFINITI LDWIII
CSC0601-04-L



REQUIRED PARTS FOR THIS PACKAGE • Autel ADAS Standard Calibration Frame • MaxiSYS tablet with ADAS Calibration Software

ADAS STANDARD FRAME LDW PACKAGE



LDW TARGET 3 PART NO: LDWTARGET3

EXPANDS LANE DEPARTURE WARNING CALIBRATION CAPABILITIES

Warns driver when vehicle begins to move out of freeway lane.

Designed to minimize caused collisions: driver error, distractions and drowsiness. **COMPATIBLE WITH THE AUTEL STANDARD FRAME >**

*Frame not included with package.

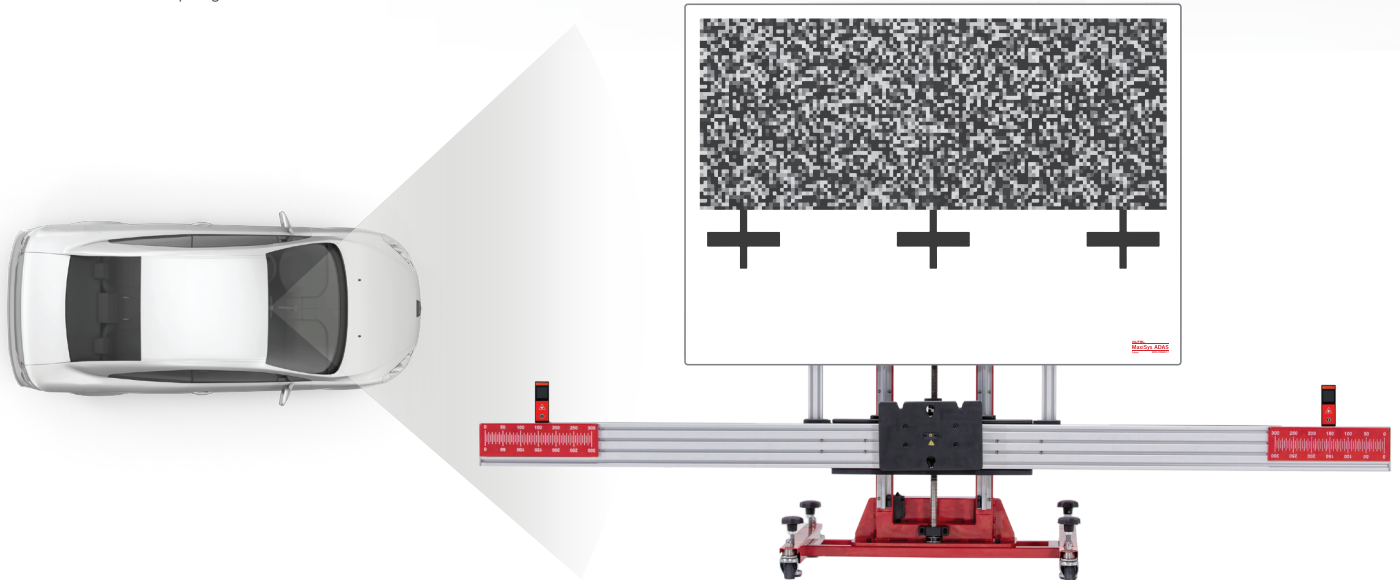

LANE DEPARTURE WARNING

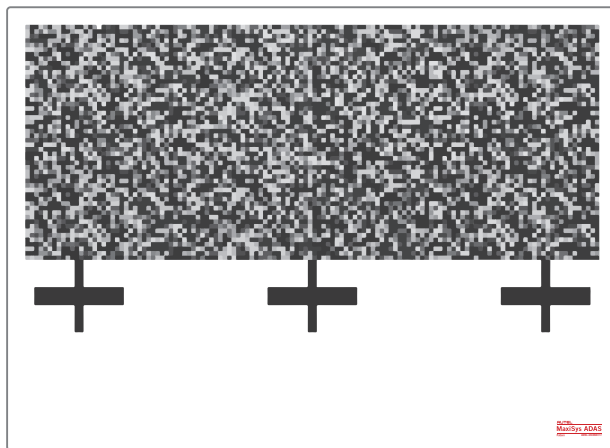

SUBARU LDWII
CSC0601-17

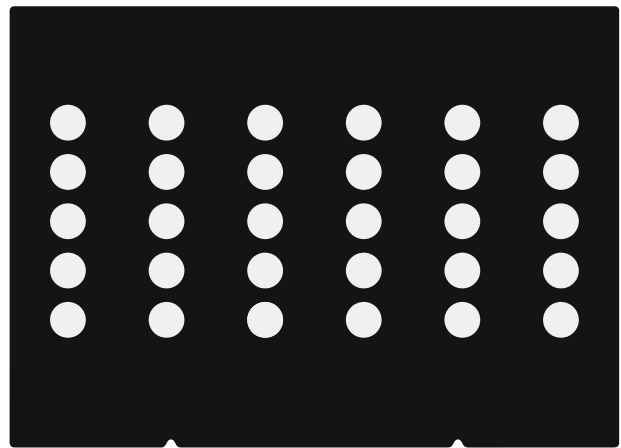

ALFA ROMEO LDWIII
CSC0601-10

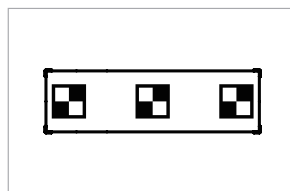

TOYOTA/LEXUS LDWIII
CSC0601-25



HYUNDAI/KIA LDWIII
CSC0701-23

REQUIRED PARTS FOR THIS PACKAGE • Autel ADAS Standard Calibration Frame • MaxiSYS tablet with ADAS Calibration Software

MA600 FRAME LDW PACKAGE



MA600 LDW TARGET 3

PART NO:
MA600LDW3

EXPANDS LANE DEPARTURE WARNING CALIBRATION CAPABILITIES

Warns driver when vehicle begins to move out of freeway lane.
Designed to minimize caused collisions: driver error, distractions
and drowsiness. **COMPATIBLE WITH THE AUTEL MA600 FRAME >**

*Frame not included with package.



LANE DEPARTURE WARNING

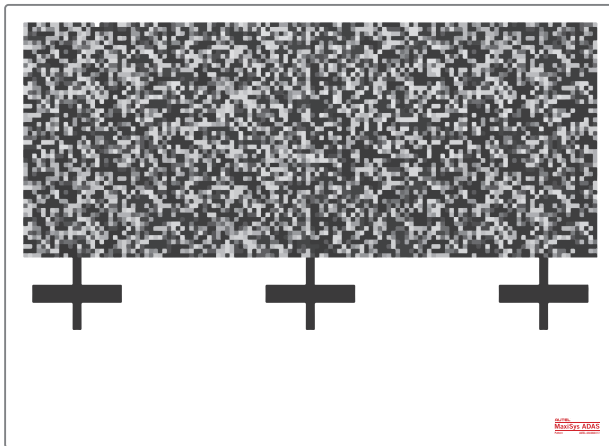

SUBARU LDWIII
CSC0601-17

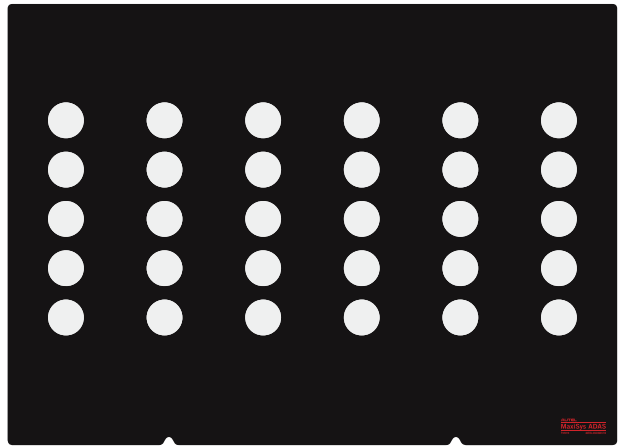

ALFA ROMEO LDWIII
CSC0601-10

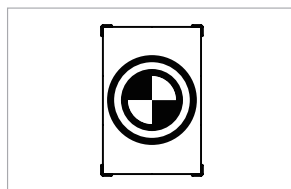

HONDA/ACURA LDWIII
CSC0601-24

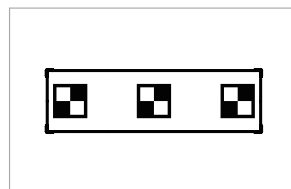

TOYOTA/LEXUS LDWIII
CSC0601-25

REQUIRED PARTS FOR THIS PACKAGE • Autel ADAS MA600 Calibration Frame • MaxiSYS tablet with ADAS Calibration Software

ADAS STANDARD FRAME **AVM . BSD . RCW . NVS PACKAGE**



ADAS CAL 1 PART NO: ADASCAL1

UPGRADE YOUR LDW PACKAGE TO AN ADAS COMPLETE

- **AVM:** Around View Monitoring
- **LDW:** Lane Departure Warning
- **RCW:** Rear Collision Warning
- **RADAR SYSTEMS:** ACC - Adaptive Cruise Control, BSM - Blind Spot Monitoring, FCW - Front Collision Warning and Park Assist Systems
- **NIGHT VISION COVERAGE:** Audi, Volkswagen & Cadillac

COMPATIBLE WITH THE AUTEL STANDARD FRAME >

*Frame not included with package.

AROUND VIEW MONITORING

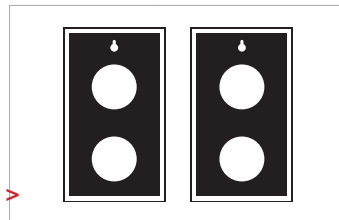

VW AVM
CSC0804-01



HONDA AVM
CSC1004-02

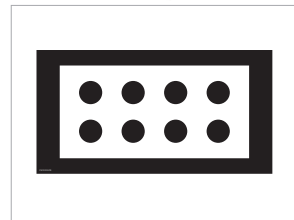

HONDA AVM
CSC1004-03

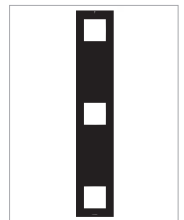

CADILLAC AVM
CSC1004-06

BLIND SPOT DETECTION



CENTER AXIS LASER BSD
CSC0500-04



RADAR CALIBRATION BOX BSD
CSC0605-01



CORNER REFLECTOR STAND BSD
CSC0800



CORNER REFLECTOR BSD
CSC0802-01

NIGHT VISION SYSTEM



VAG/GM CALIBRATOR NVS
CSC0603-01



MERCEDES STAND NVS
CSC0803-01

REAR COLLISION WARNING

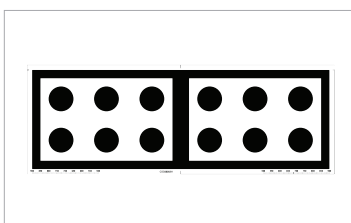

VW RCWI
CSC0806-01

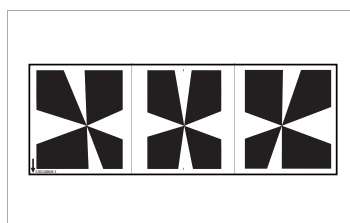

MERCEDES RCWI
CSC1006-01

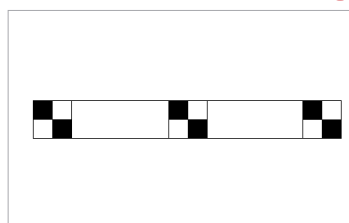

NISSAN RCWI
CSC1006-03

ADAPTIVE CRUISE CONTROL

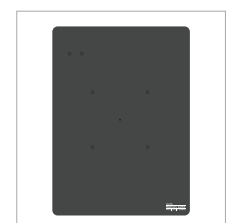

RADAR CALIBRATION PLATE ACC
CSC0602-02

REQUIRED PARTS FOR THIS PACKAGE • Autel ADAS Standard Calibration Frame • MaxisYS tablet with ADAS Calibration Software

MA600 FRAME **AVM .RCW .NVS PACKAGE**



MA600 CAL 1 PART NO: MA600CAL1

**UPGRADE YOUR MA600 LDW PACKAGE
COMPATIBLE WITH THE AUTEL MA600 FRAME**

*Frame not included with package.

- **AVM:** Around View Monitoring
- **RCW:** Rear Collision Warning
- **NIGHT VISION COVERAGE:** Audi, Volkswagen & Cadillac

AROUND VIEW MONITORING

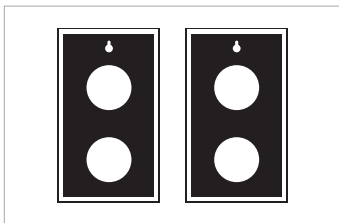

VW AVM
CSC0804-01

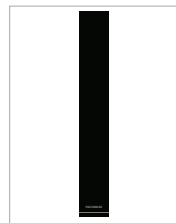

HONDA AVM
CSC1004-02

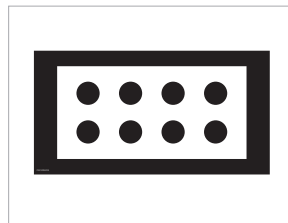

HONDA AVM
CSC1004-03

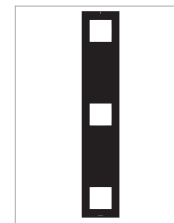

CADILLAC AVM
CSC1004-06



NIGHT VISION SYSTEM



MERCEDES STAND NVS
CSC0803-01

REAR COLLISION WARNING

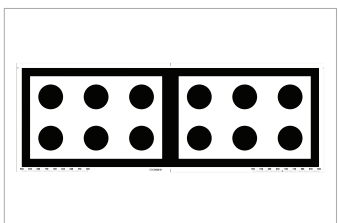

VW RCWI
CSC0806-01

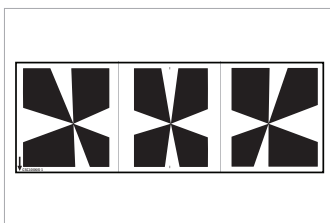

MERCEDES RCWI
CSC1006-01

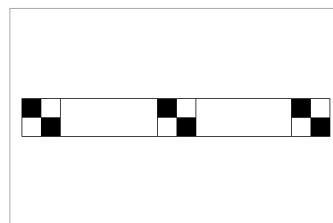

NISSAN RCWI
CSC1006-03



BLIND SPOT DETECTION



CORNER REFLECTOR STAND BSD
CSC0800



CORNER REFLECTOR BSD
CSC0802-01

REQUIRED PARTS FOR THIS PACKAGE • Autel ADAS MA600 Calibration Frame • MaxiSYS tablet with ADAS Calibration Software

STANDARD & MA600 FRAME ACC .AVM .BSD .RCW PACKAGE



ADAS CAL 2

PART NO:
ADASCAL2

EXPAND YOUR FRAMES CAPABILITIES

COMPATIBLE WITH THE AUTEL STANDARD & MA600 FRAMES >

*Frame not included with package.

- **AVM:** Around View Monitoring
- **LANEWATCH:** Camera-Based Blind Spot
- **RCW:** Rear Collision Warning
- **RADAR SYSTEMS:** ACC - Adaptive Cruise Control, BSM - Blind Spot Monitoring, FCW - Front Collision Warning

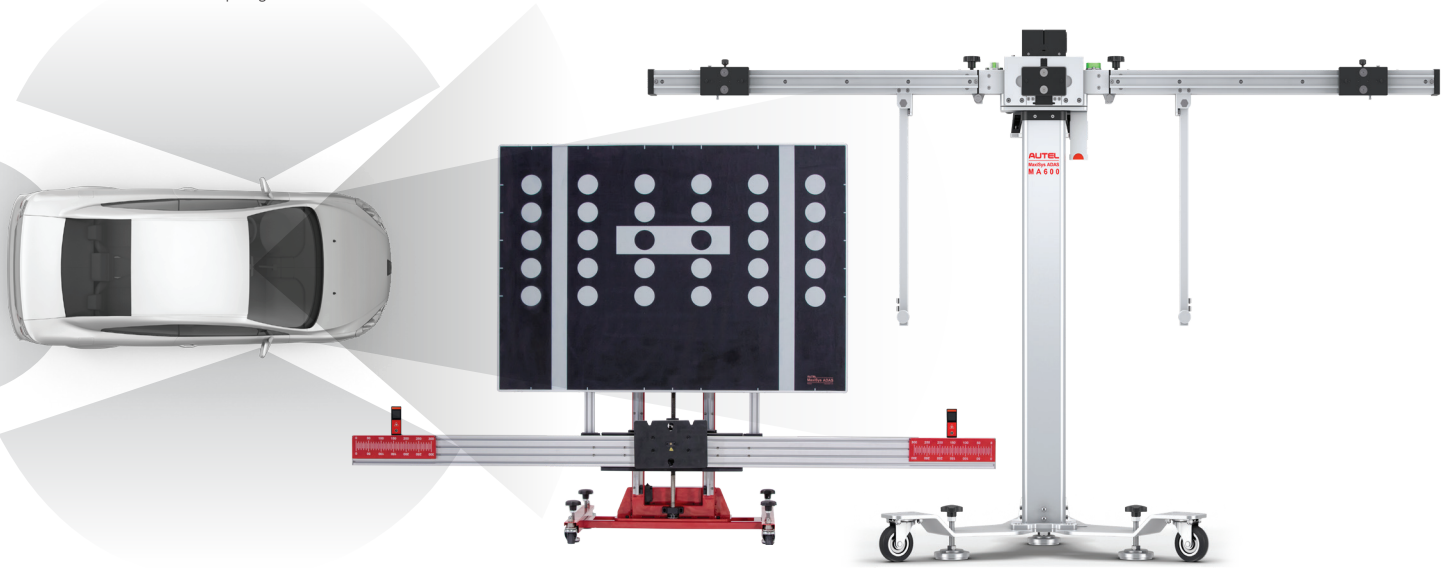

AROUND VIEW MONITORING

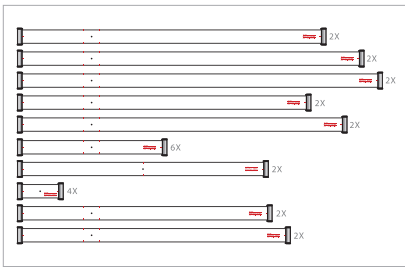

TOYOTA AVM
CSC1004-10

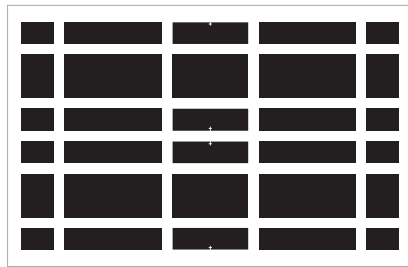

MITSUBISHI AVM
CSC1004-09

ADAPTIVE CRUISE CONTROL

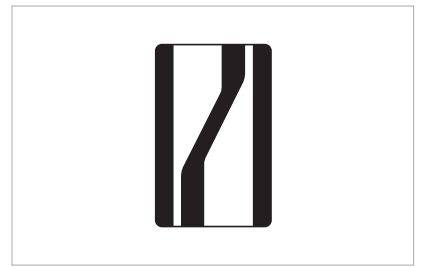

HITACHI RADAR PLATE ACC
CSC0802-03

BLIND SPOT DETECTION



TARGET STAND BSD
CSC0802

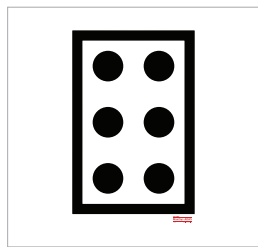

HONDA LANEWATCH BSD
CSC0805-02

REAR COLLISION WARNING

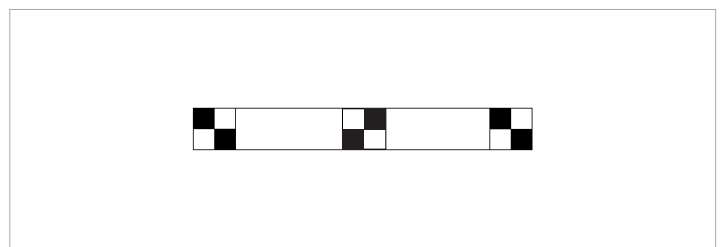

NISSAN RCWII
CSC1006-05

REQUIRED PARTS FOR THIS PACKAGE • Autel ADAS Standard OR MA600 Calibration Frame • MaxiSYS tablet with ADAS Calibration Software

MA600 FRAME ACC .NVS .BSD PACKAGE



MA600 CAL 3 PART NO: MA600CAL3

THE EXPAND CALIBRATION CAPABILITIES FOR YOUR MA600

- **RADAR SYSTEMS:** ACC - Adaptive Cruise Control, BSM - Blind Spot Monitoring, FCW - Front Collision Warning
- **NIGHT VISION COVERAGE:** Audi, Volkswagen & Cadillac

COMPATIBLE WITH THE AUTEL MA600 FRAME >

*Frame not included with package.

NIGHT VISION SYSTEM



VAG/GM CALIBRATOR NVS
CSC0603-01

BLIND SPOT DETECTION



RADAR CALIBRATION BOX BSD
CSC0605-01



MOUNTING PLATE BSD
MA600RAP

ADAPTIVE CRUISE CONTROL

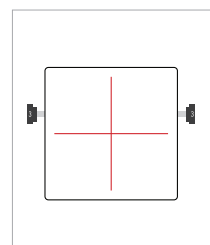

REFLECTOR ACC
CSC0602-01

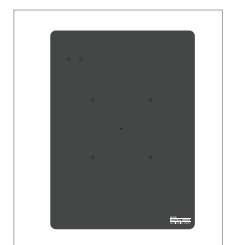

RADAR CALIBRATION PLATE ACC
CSC0602-02

REQUIRED PARTS FOR THIS PACKAGE • Autel ADAS MA600 Calibration Frame • MaxiSYS tablet with ADAS Calibration Software

STANDARD FRAME ACC .AVM .LIDAR .NVS .RCW PACKAGE



ADAS CAL 4 PART NO. ADASCAL4

EXPAND YOUR FRAMES CAPABILITIES
COMPATIBLE WITH THE AUTEL STANDARD FRAME >

*Frame not included with package.

- **AVM:** Around View Monitoring
- **LIDAR:** Pulsed Laser to Detect Distance, Velocity & Angle
- **NIGHT VISION COVERAGE:** Audi, Volkswagen & Toyota
- **RADAR SYSTEMS:** ACC - Adaptive Cruise Control
- **RCW:** Rear Collision Warning

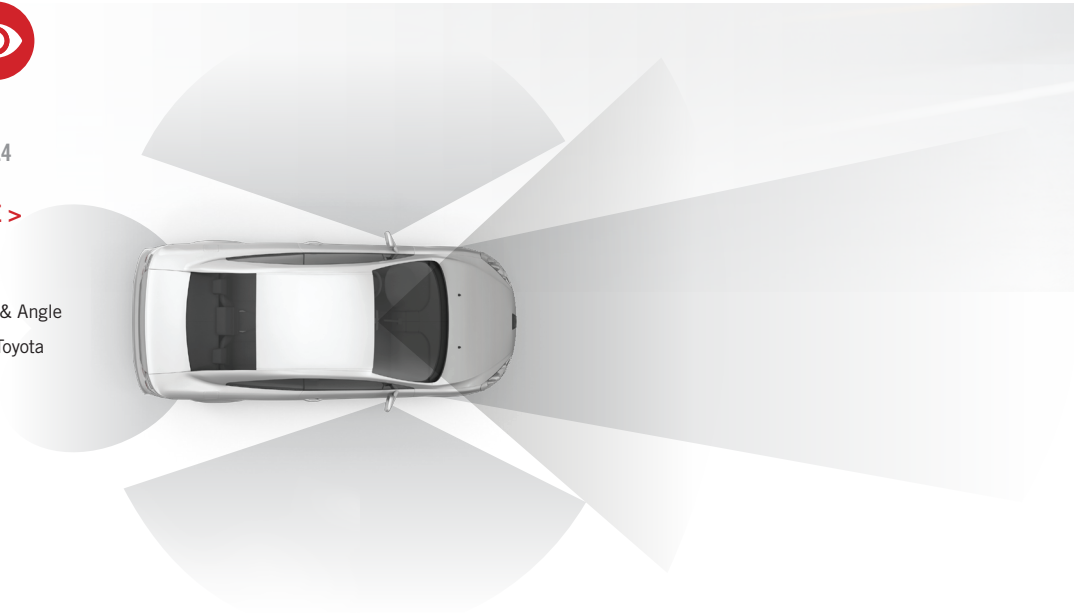

LIDAR



VW/AUDI CALIBRATION BOARD LIDAR
 CSC0602-04

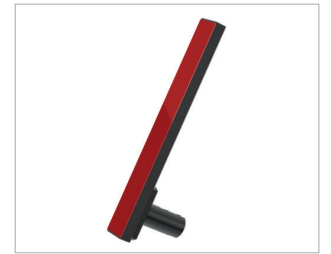

TOYOTA REFLECTOR LIDAR
 CSC0802-04

ADAPTIVE CRUISE CONTROL



VW ADR CALIBRATION PLATE ACC
 CSC0602-08

REAR COLLISION WARNING

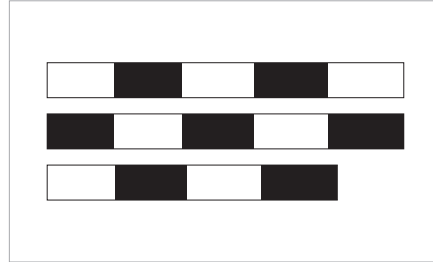

MERCEDES RCWII
 CSC1006-02

NIGHT VISION SYSTEM

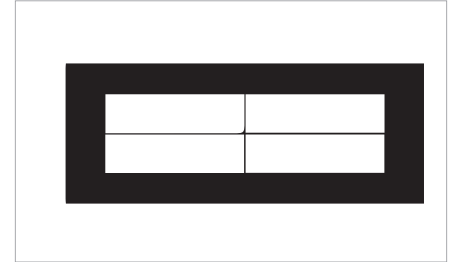

LEXUS PATTERN NVS
 CSC0603-03

AROUND VIEW MONITORING

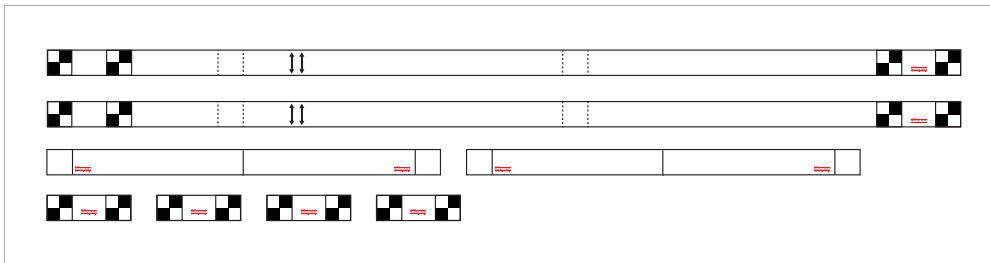

HYUNDAI/ KIA AVM
 CSC1004-04

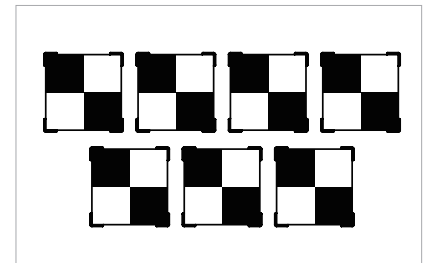

NISSAN AVM
 CSC1004-11

REQUIRED PARTS FOR THIS PACKAGE • Autel ADAS Standard Calibration Frame • MaxiSYS tablet with ADAS Calibration Software

MA600 FRAME ACC .AVM .LIDAR .NVS .RCW PACKAGE



MA600 CAL 4 PART NO: MA600CAL4

EXPAND YOUR FRAMES CAPABILITIES
COMPATIBLE WITH THE AUTEL MA600 FRAME >

*Frame not included with package.

- **AVM:** Around View Monitoring
- **LIDAR:** Pulsed Laser to Detect Distance, Velocity & Angle
- **NIGHT VISION COVERAGE:** Audi, Volkswagen & Toyota
- **RADAR SYSTEMS:** ACC - Adaptive Cruise Control
- **RCW:** Rear Collision Warning

LIDAR



VW/AUDI CALIBRATION BOARD LIDAR
CSC0602-04



TOYOTA REFLECTOR LIDAR
CSC0802-04

ADAPTIVE CRUISE CONTROL



VW ADR CALIBRATION PLATE ACC
CSC0602-08

REAR COLLISION WARNING

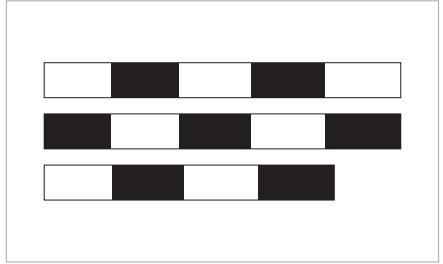

MERCEDES RCWII
CSC1006-02

NIGHT VISION SYSTEM

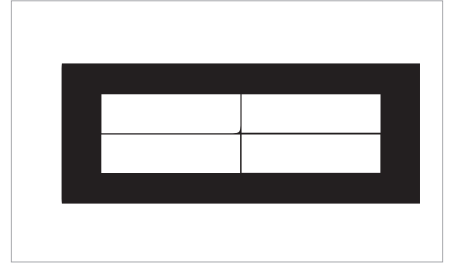

LEXUS PATTERN NVS
CSC0603-03

AROUND VIEW MONITORING

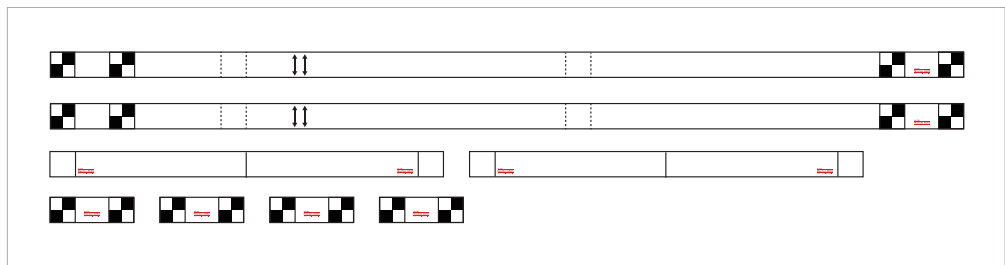

HYUNDAI/ KIA AVM
CSC1004-04

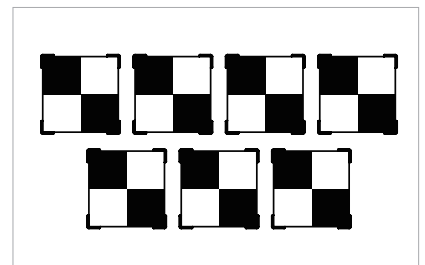

NISSAN AVM
CSC1004-11

REQUIRED PARTS FOR THIS PACKAGE • Autel ADAS MA600 Calibration Frame • MaxiSYS tablet with ADAS Calibration Software

ADAS STANDARD FRAME **DIGITAL ADAS**

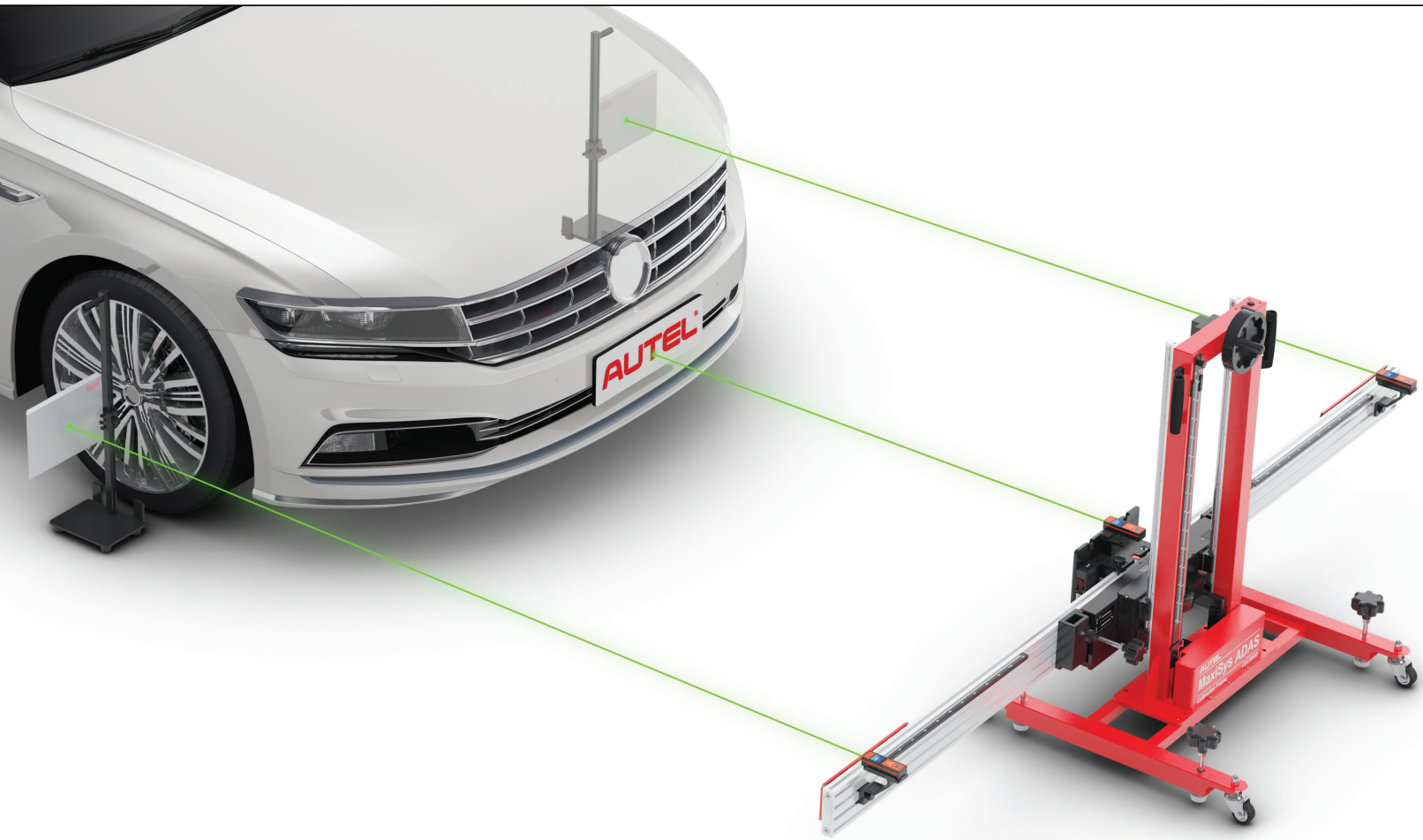

DIGITAL ADAS PART NO: DIGITALADAS

EXPAND YOUR DIGITAL CALIBRATION CAPABILITIES
COMPATIBLE WITH THE AUTEL STANDARD FRAME >

*Frame not included with package.



CENTER DIGITAL TAPE MEASURE BRACKET



FRONT WHEEL DIALS (LEFT & RIGHT)
CSC0500-05L & CSC0500-05R



DIGITAL TAPE MEASURE CROSSBAR BRACKETS (2X)



DIGITAL TAPE MEASURE (3X)

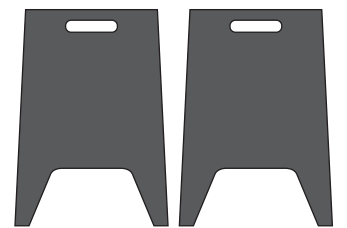

DIAL PLACEMENT BOARDS (2X)

REQUIRED PARTS FOR THIS PACKAGE • Autel ADAS Standard Calibration Frame • MaxiSYS tablet with ADAS Calibration Software

ADAS STANDARD FRAME **ACCESSORY**

ADAS ACCESSORY

PART NO:
ADASACCESSORY

ALIGNS THE FRAME TO THE VEHICLE CENTERLINE

- **L-SHAPED BRACKET:** Assist with measuring distance from front wheel for frame placement
- **LASER ASSIST MIRROR:** Easier viewing under the car to set centerline
- **PLUMB BOB:** Transfer centerline of vehicle to point on ground
- **LASER REFLECTOR:** Used with Five Line or Two Line laser to find vehicle centerline
- **FIVE LINE LASER:** Used to find perpendicular axis from any point
- **TWO LINE LASER:** Used to align calibration frame to vehicle centerline

COMPATIBLE WITH THE AUTEL STANDARD FRAME >

*Frame not included with package.



TRAVEL CASE
INCLUDED

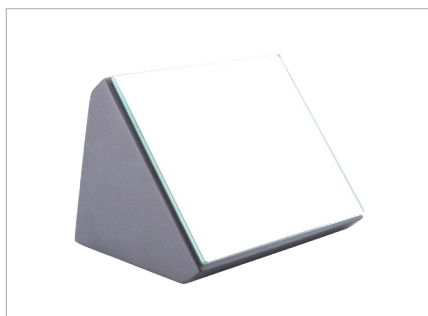
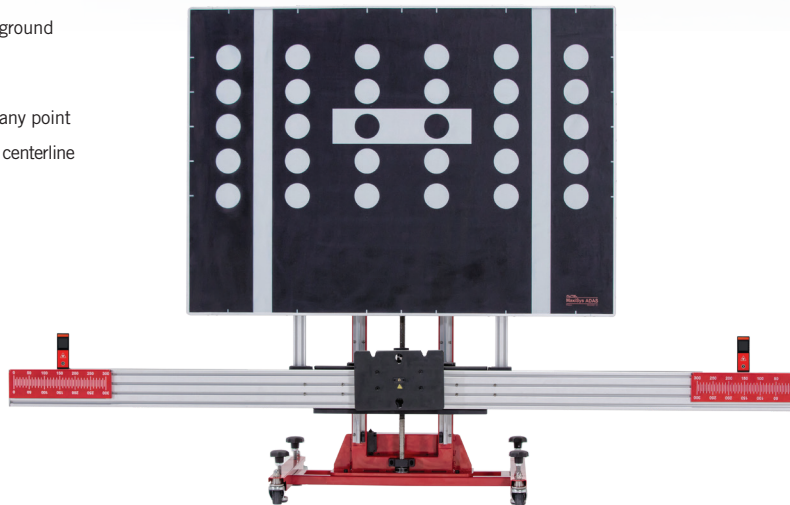

LASER ASSIST MIRROR
CSC1500-06



TWO LINE LASER
CSC1500-03



PLUMB BOB
CSC1500-07



L-SHAPED BRACKET
CSC1500-04

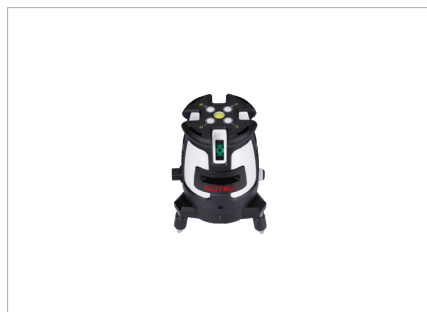

FIVE LINE LASER
CSC1500-05



LASER REFLECTOR
CSC1500-08

REQUIRED PARTS FOR THIS PACKAGE • Autel ADAS Standard Calibration Frame • MaxiSYS tablet with ADAS Calibration Software

MA600 CASE

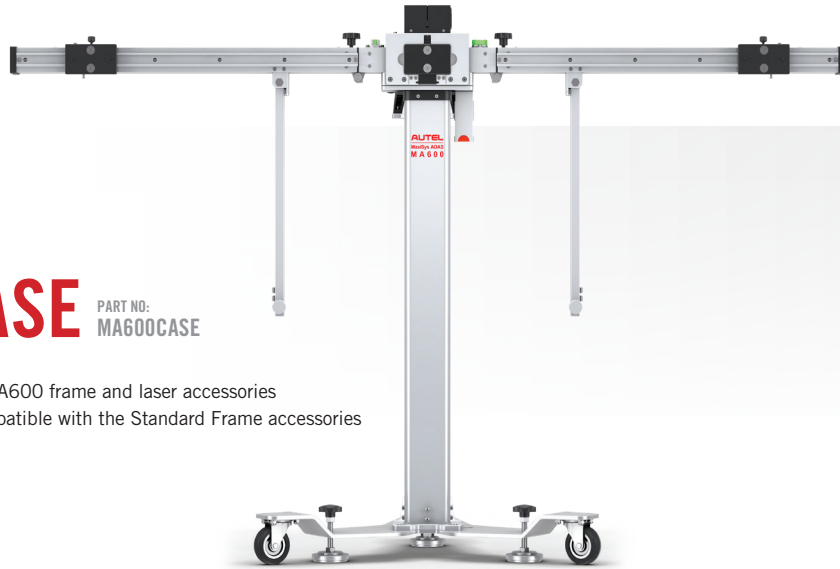

MA600 CASE

PART NO:
MA600CASE

FOR THE TECH ON THE GO

- Allows easier transport of the MA600 frame and laser accessories
- Laser Accessories bag also compatible with the Standard Frame accessories

*Frame not included with package.



MA600 BASE
STORAGE BAG



MA600 CROSSBAR
STORAGE BAG



LASER ACCESSORIES
STORAGE BAG



MA600 MAIN COLUMN
STORAGE BAG

REQUIRED PARTS FOR THIS PACKAGE • Autel ADAS MA600 Calibration Frame • MaxiSYS tablet with ADAS Calibration Software

AUTEL[®] MAXISYS™ ADAS CALIBRATION

IA800

INTELLIGENT ADAS

THE FASTEST, EASIEST, & MOST PRECISE SET UP AVAILABLE TODAY

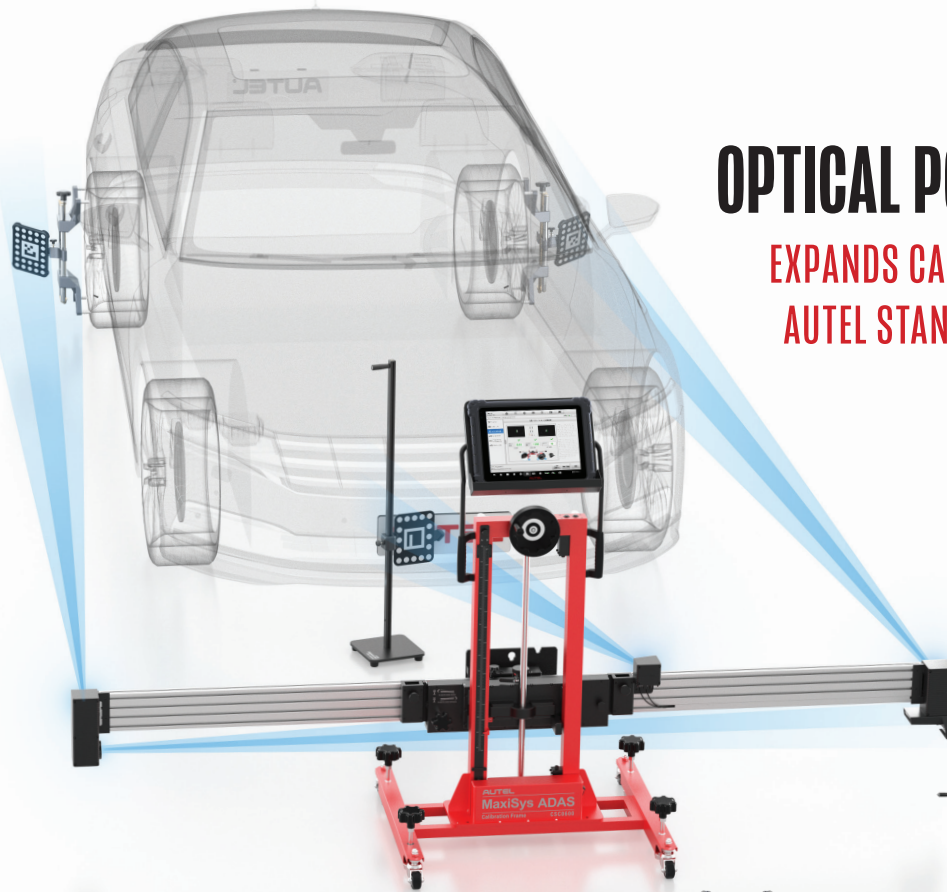

OPTICAL POSITIONING SYSTEM

EXPANDS CAPABILITY OF YOUR EXISTING
AUTEL STANDARD CALIBRATION FRAME

NO MORE MECHANICAL MEASURING
FRAME
PLACEMENT
IN AS LITTLE AS
1 MINUTE



LEFT CAMERA UNIT
(2 CAMERAS + 4 CABLES)
CSC0500-06



CENTER CAMERA
CSC0500-06



RIGHT CAMERA UNIT
(3 CAMERAS)
CSC0500-06



WHEEL CLAMP (4 PCS)
CSC0500-07-LF, CSC0500-07-LR
CSC0500-07-RF, CSC0500-07-RR



ALIGNMENT AID
CSC0500-08



TARGET (2 PCS)
CSC0500-09-LF
CSC0500-09-RF



TARGET (2 PCS)
CSC0500-09-LR
CSC0500-09-RR



STEERING WHEEL LOCK



24V POWER ADAPTER



WEDGE-SHAPED BLOCK (2 PCS)



TABLET SUPPORT

REQUIRED PARTS FOR THIS PACKAGE (SOLD SEPARATELY) • Autel ADAS Standard Calibration Frame • MaxiSYS tablet with ADAS Calibration Software

AUTEL[®]

SMARTER DIAGNOSTICS

STARTS HERE



PART NO:
ADASUPGRADE



ONE TIME PURCHASE

NOW YOU CAN ADD
ADAS SOFTWARE TO
ANY MAXISYS TABLET

Autel ADAS Software features easy-to-use graphic instruction to guide you through the entire calibration process.



Autel ADAS Software for the Standard & MA600 Frame System is compatible with the following MaxiSYS Tablets:

TABLET COMPATIBILITY

- MS908
- MS908P
- MS908S
- MS908SP
- MSELite
- MS909
- MS919
- MSUltra

